

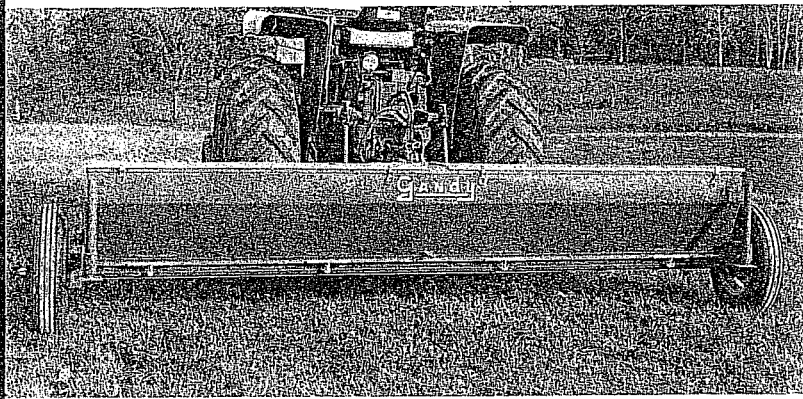

10T Series Fertilizer Spreaders

6, 8, 10 & 12-foot models

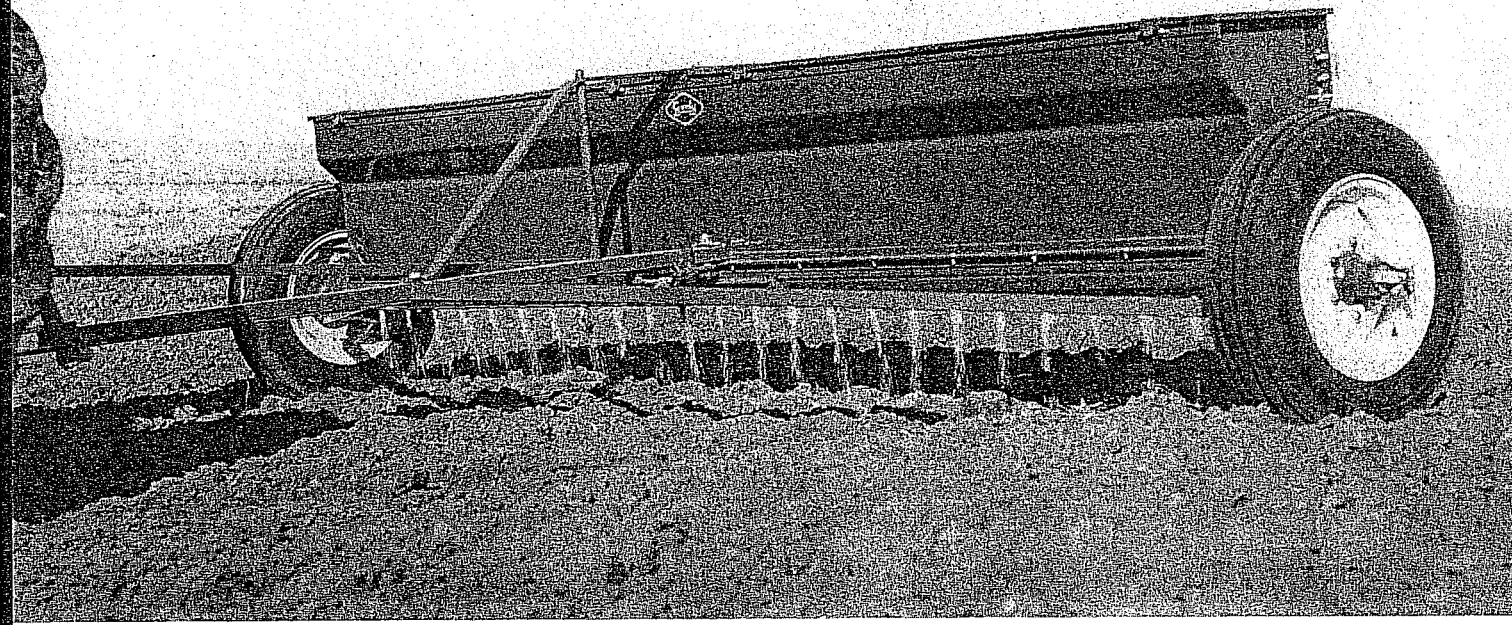

Trailer, 3-pt hitch end-wheel drive,
& Implement-mounted
Spreaders

OPERATOR'S MANUAL

Limited Warranty

The Gandy Company warrants all material and workmanship on equipment delivered to be free of defects for a period of twelve months from date of original purchase. Products used on a commercial, rental or leased basis are warranted for 90 days. Any part or parts thought to be defective within these warranty periods are to be returned through your servicing dealer or distributor to the Gandy Company's plant. Distributor must receive authorization from Gandy Company to return items under warranty. An authorization number will be issued and must be clearly visible on all packages returned to the factory. If found defective by Gandy Company, replacement parts will be forwarded free of charge, prepaid. No service charge or expense on the equipment will be allowed unless such expense has been previously authorized in writing by the Gandy Company. Serial number and model of the unit involved is required by the Gandy Company on all warranty claims. Gandy Company policy is to improve products whenever it is practical to do so. It reserves the right to make changes or add improvements at any time without incurring any obligation to make such changes on products sold previously. This warranty does not apply to products altered by users after the point of manufacture.

This warranty against defects in material and workmanship is in lieu of all other warranties, expressed or implied, and there are no other warranties of any kind whatsoever including, but not limited to, any implied warranty of merchantability or fitness for any particular purpose. In no event shall the company be liable for any incidental or consequential damages whether for breach of warranty, for breach or repudiation of any other term or condition hereof, or for negligence, on the basis of strict liability, or for any other reason.

This manual contains information that is correct at the time of printing; however, Gandy Company reserves the right to change specifications, models, equipment or prices without incurring obligation.

EXTRA EQUIPMENT

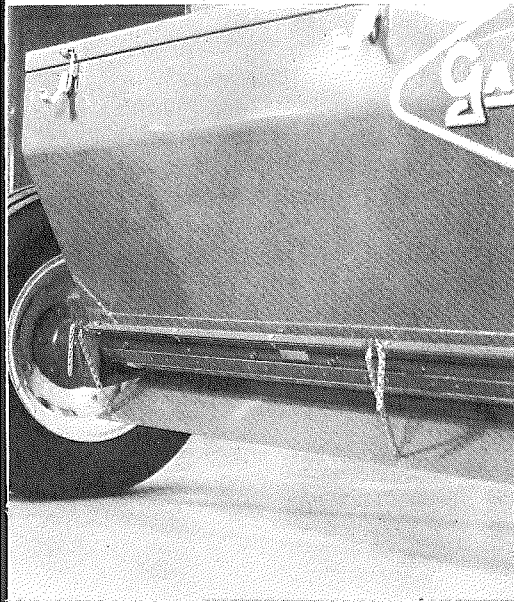

Spread plates

Spreading plates are furnished with T Series models and are available for S Series. Spread plates for S Series must be ordered with chain hook package 01A5214 for proper installation.

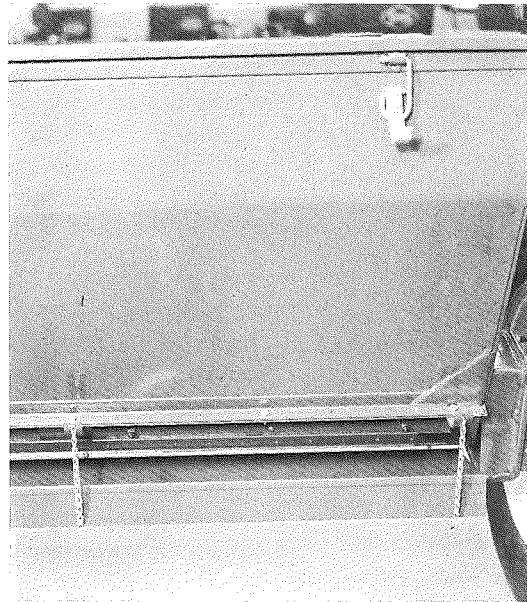

Calibration pan

Extra equipment for all models, calibration pans can be carried on the spread plate of the T Series, or suspended under the hopper on S Series with the chain hook package 01A5214.

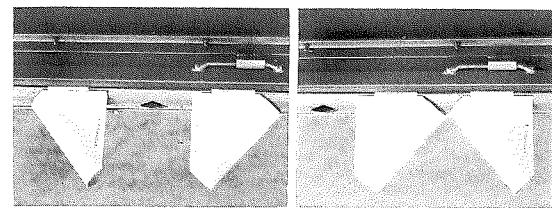

Deflectors

Material may be banded by using deflectors illustrated above, or they can be switched into side-by-side position for side-dressing. Each deflector clips over lip of side rail and is secured in place with clamp, bolt and nut.

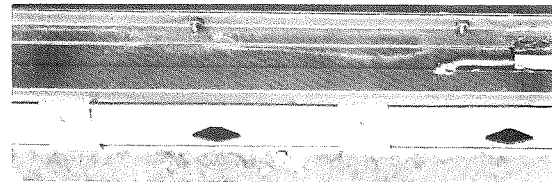

Hole closures

To close off openings for banding or side-dressing, a two-piece hole closure clips over hanger rail lip and is secured with clamp, bolt and nut.

CARE AND MAINTENANCE OF THE GANDY SPREADER

ASSEMBLY

To begin with, your spreader must be assembled properly in order to function properly. Detailed instructions begin on page 6 and should be followed very carefully.

NOTE: Be sure to tighten all bolts and nuts after the first short run.

LUBRICATION

(NLGI No. 2 grease, lithium 12 hydroxystearate, high temperature, is recommended.)

There are seven fittings which require twice-a-day lubrication and one which requires periodic lubrication, as needed. The latter is on the knee joint at the rear of the hitch pole.

Wheel hub bearings and collars (4)—The bearings for the two wheel hubs and the two wheel-hub collars

have built-in grease reservoirs and should be greased generously twice daily. When lubricated, grease should come out the parting line between the two sections of collar, and also out the inside end of the wheel hub.

IMPORTANT: The wheel bearings are not designed for high speed road towing.

Rotor bearings (3)—The three rotor bearings are porous bronze, with a grease well and should be greased sparingly, twice daily. Do not over-grease, as this will force excess grease out into the spreader compartment, possibly causing interference with feeding of material out through openings in hopper bottom.

Knee joint (1)—The knee joint at the rear of the hitch pole should be greased periodically to ensure smooth lever operation.

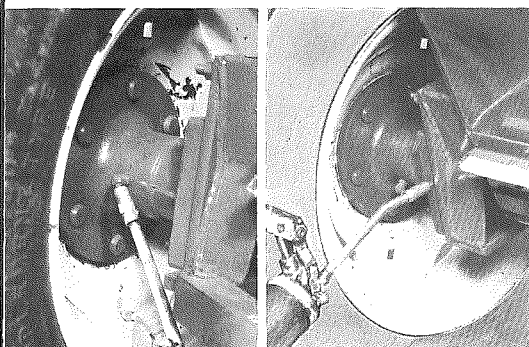

Wheel bearings—generously, twice daily

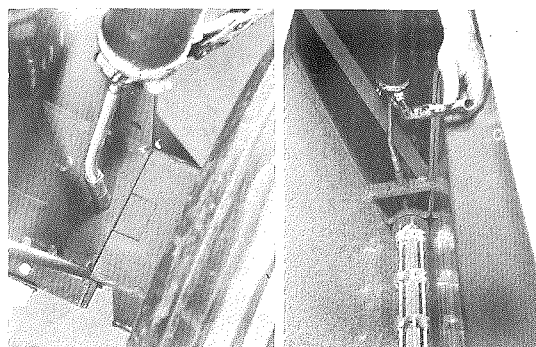

Rotor bearings—sparingly, twice daily

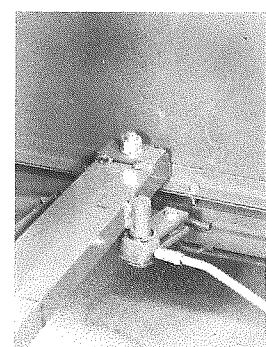

Knee joint—periodically

CLEANING

1. Run spreader until the hopper is empty or nearly so.
 2. Move the gauge to the wide open position and pull the rate control slide open. Remaining fertilizer may be caught by drop cloth or calibration pans if desired. Sweep out material.
 3. To remove rotors, pull out stub drive as shown in the first illustration below. Reach inside hopper, slide rotors to end of hopper until free of center bearing and lift out.
 4. Sweep loose material out hopper openings. Wipe clean, so there is no fertilizer left inside of hopper or on outside of hopper bottom.
- NOTE:** Steps 5 & 6 may be more easily completed if hopper is inverted for better access to bottom & slide.
5. To clean any buildup of material between slide and bottom, disassemble the slide assembly by removing the nuts, nylon washers, self-tapping phillips screws and slide hangers. Wipe clean. Coat very lightly with lubricant.

6. Reposition slide on bottom, making sure slide rail securely catches lip of rail on bottom and rear hangers and is positioned over the cam gauge stud. Ensure that slide is properly aligned and replace self-tapping phillips head screw through rear hangers; replace nylon washers and nuts. Check to see that slide moves smoothly but snugly, and openings in bottom are quite round at small gauge settings, are symmetrical at larger openings, and are not distorted by uneven tension from hanger straps. If distortion is noticeable, correct the tension by adjusting accordingly.
7. If spreader will not be used for several days, or will be stored until the next season, use an oily cloth to cover both inside and outside of hopper bottom and slide with a light coating of oil.

IMPORTANT: Be sure to install rotors as shown below, right, with "hooks" pointed forward, when preparing for next use. Right rotor is painted red and has "R" on the end. Left is black and has "L" on the end.

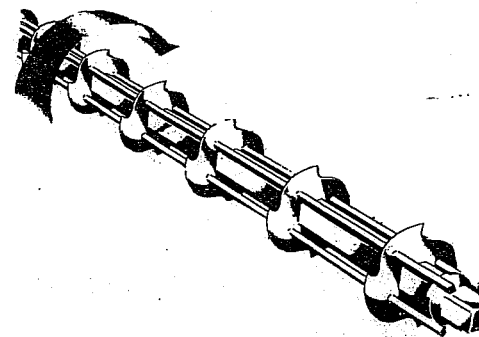
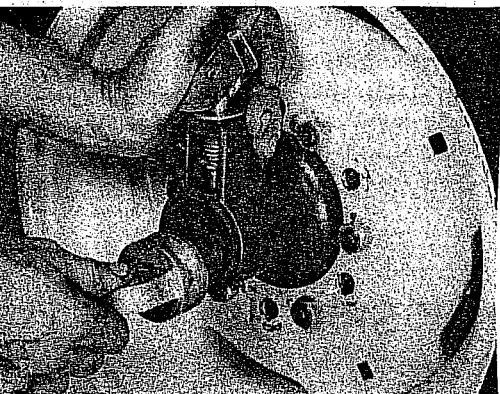

FIELD OPERATION & CALIBRATION

1. Observe the important service and safety decals located on the spreader hopper and/or drives.

WARNING

MOVING PARTS

- Keep fingers out of openings in hopper bottom at all times
- Keep fingers, hands and arms out of hopper when rotor turning
- Keep tools out of openings in hopper bottom to avoid damage to bottom and slide

Part No. N02-0057-000

CAUTION

Keep fingers, hands, feet, and clothing out of all chains, sprockets, belts, and pulleys! Failure to do so can cause personal injury.

Do not ride on machine!

Keep fingers out of the hopper when rotor bar is turning. Getting fingers or clothing caught in rotor can cause personal injury!

Part No. N02-0014-010

IMPORTANT

Tighten all bolts after first two hours of field use!

To prevent moisture from entering openings in hopper bottom, close slide overnight and whenever applicator is not in use!

Remove rotors and bearings for cleaning and storage!

Do not over lubricate bearings as excess lubricant may interfere with material flow!

Part No. N02-0014-020

2. Fill hopper and close lids. Check to see that spread plates or deflectors, if any, are secure for desired placement.

3. Set cam gauge for individual material from charts provided. Use top edge of the stop as the gauge point. If material is not listed, a trial setting of 40 will, for many available fertilizers, apply approximately 100 pounds per acre traveling at 5 mph.

4. Engage motor, if a motor-driven model, or ground drive. Ground drive spreaders have a three-position clutch lever in each hub as shown on page 2.

5. Check calibration by one of two methods described below—either calibration pan or known area method. In conducting rate checks, always maintain actual field operating speed. To check your ground speed, use the following chart comparing speed to distance traveled in one minute:

1 kph 2.7 m	2 kph 54 m	3 kph 80 m	4 kph 107 m	5 kph 134 m	6 kph 161 m	7 kph 188 m	8 kph 214.5 m	9 kph 241 m	10 kph 268 m
1 mph 88 ft	2 mph 176 ft	3 mph 264 ft	4 mph 352 ft	5 mph 440 ft	6 mph 528 ft	7 mph 616 ft	8 mph 704 ft	9 mph 792 ft	10 mph 880 ft

(A Gandy land measuring wheel in either metric or English units gives a quick, accurate one-man measurement of this important distance check.)

6. After checking application rate, apply material to fields.

7. Close slide to shut off material flow. Also, to prevent moisture from entering openings in hopper bottom, close slide overnight and whenever applicator is not in use.

HOPPER ASSEMBLY

Hubs and wheels

Note: To prevent possible damage to hopper bottom, be sure to leave protective crating in place until unit is completely assembled.

1. Install axles, if not in place.
2. Install hubs. Secure collars using extra nuts and lock washers on long bolts.
3. Install wheels, with rims either dished in or out as desired, with bolts and nuts.

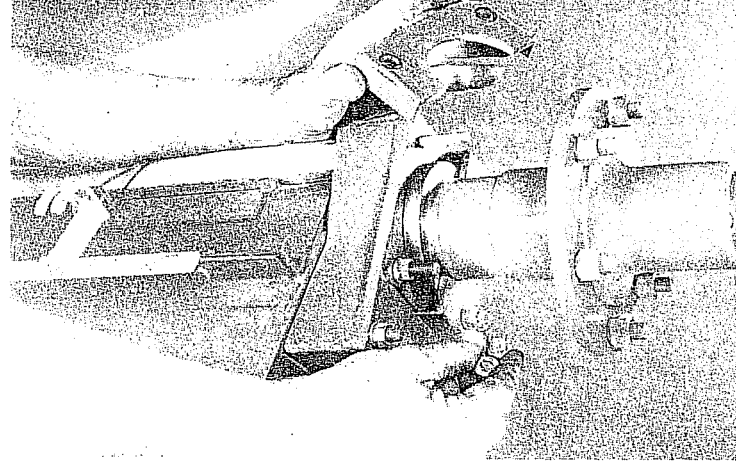

Rain trough and rotors

1. With hopper on its back (gauge up), remove rain trough, covers and hardware bag.
2. Fasten rain trough in place over center frame with drive screw.
3. Install rotors, placing silver bar at right end. Secure with stub drive assemblies.

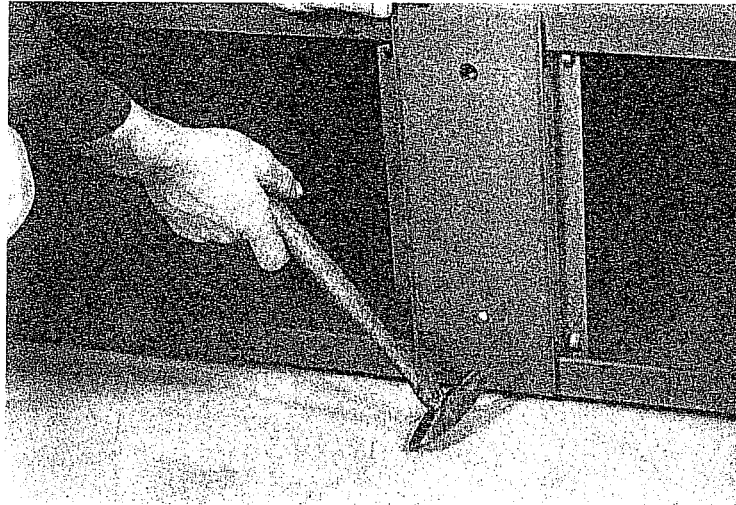

Poles and braces

1. Bolt right brace to right axle using hex screw, lock washer and nut.
2. Bolt right brace to right axle, using hex screw and lock nut.
3. Bolt right brace to tab on pole with hex screw and lock nut.
4. Bolt left brace to axle and tab on pole.

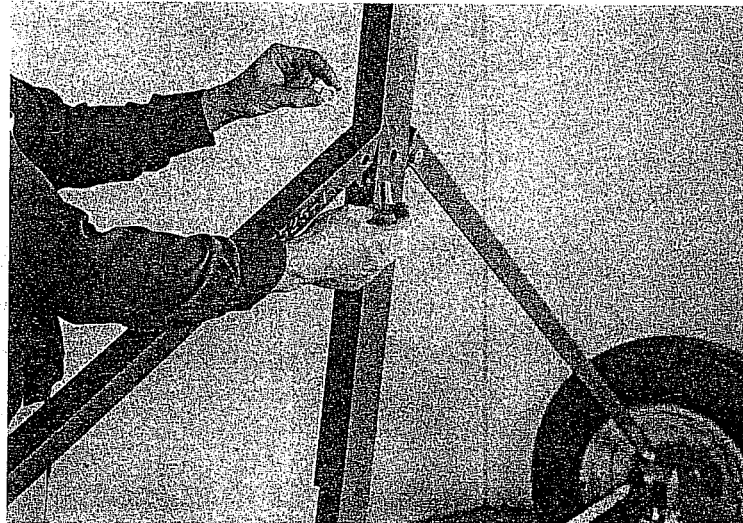

Center brace

1. Bolt center brace upright to pole, using lock washer and nut.
2. Bolt center brace to upright, using lock washer and nut.
3. Bolt center brace to center frame of hopper, placing lock washer on hex screw before threading into nut which is welded in place on lower side of center frame.
4. Bolt center brace to pole using hex screw, lock washer and nut.

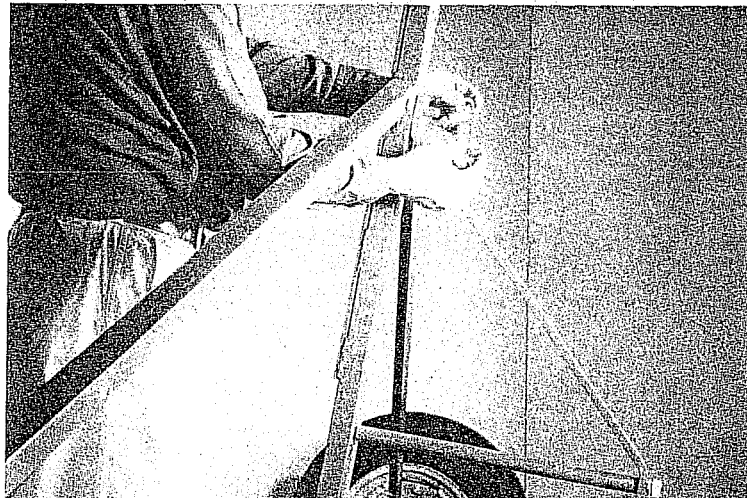

ASSEMBLY (continued)

Slide-knee lever connection

1. Pull down on outer end of pole to bring hopper to upright position.
2. Free the connector link which is wired to the rate-control slide.
3. Remove cotter pin from clevis pin in knee lever on hopper end of pole.
4. Place connector link in knee lever clevis and reinsert clevis pin. Secure with cotter pin.

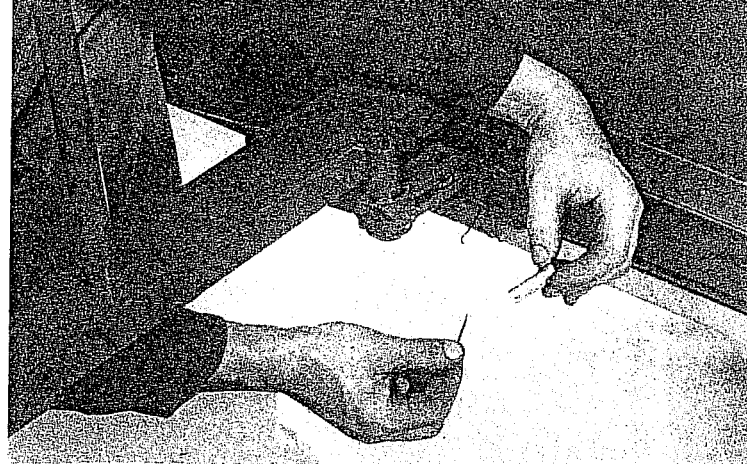

Shut-off lever

1. Bolt lower part of shutoff lever in place on right side of pole. Place welded-in pin to right. Use bolt, placing a wrought washer on each side of lever.
2. Secure with castellated nut. Draw just tight enough to hold lever in position. (Not too tight, or lever can't be moved easily.) Lock with cotter pin.
3. Bolt upper part of shutoff lever to lower part with hex screw, lock washer, and nut. **Note:** By reversing lever, five positions are available.

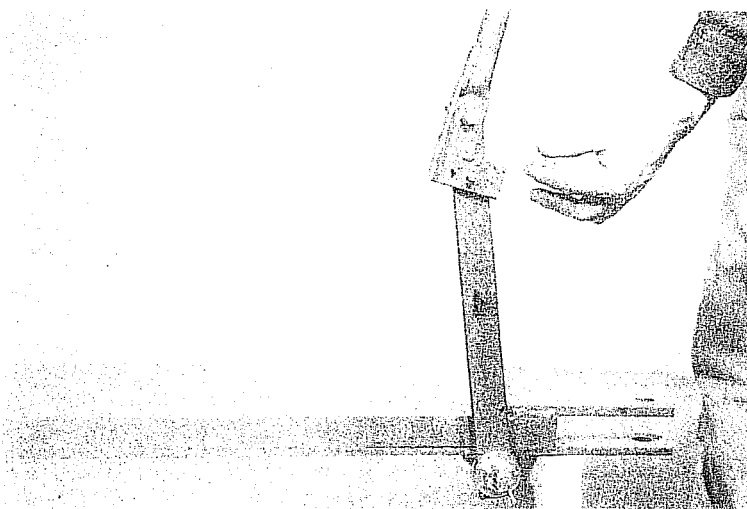

Drag link-shutoff lever

1. Connect end of drag link with one hole to knee lever. Secure with cotter pin.
2. Connect other end of drag link to shutoff lever. Secure with cotter pin. **Note:** With the three holes in the drag link, and the five positions for the upper part of the shutoff lever, a total of 15 positions are available for the top end of the lever.

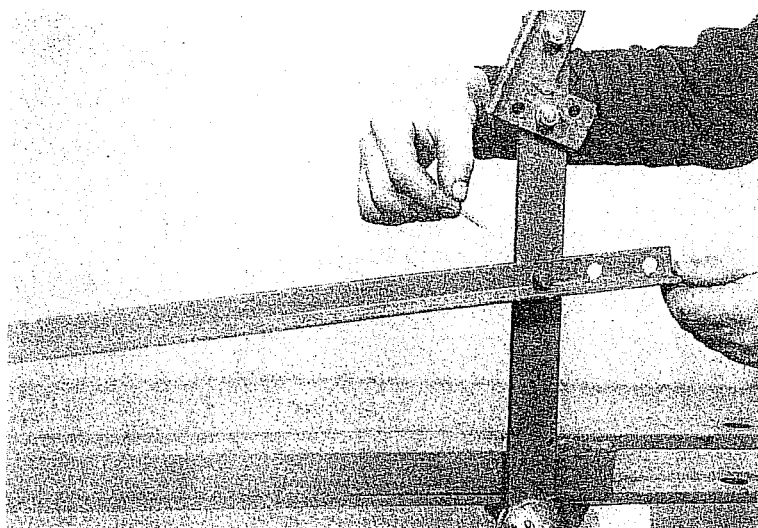

Lids and locks

1. Install lids on whichever side of hopper is desired. Secure with clevis pin and cotter pin.
2. Install cover locks in "hinge halves" on side of hopper opposite cover hinges. Secure with cotter pins.
3. Remove wooden protective strip from bottom of hopper.

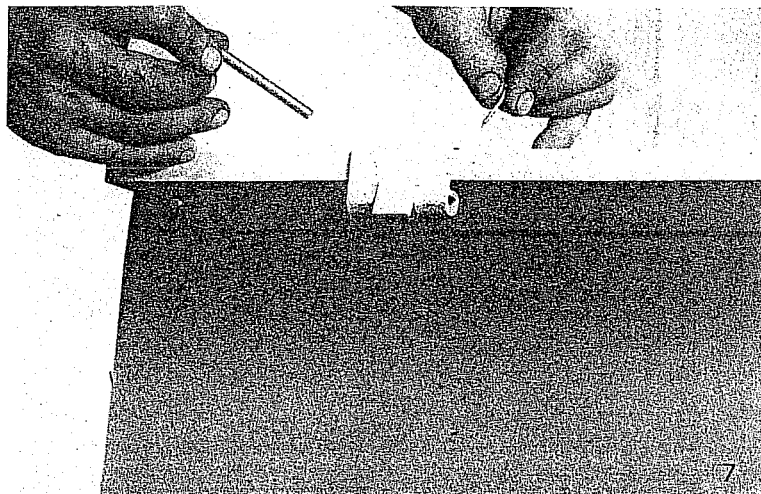

IMPORTANT: After a short period of use, check nuts and bolts. Tighten if necessary. **CAUTION:** Do not trail machine behind car or truck. Wheel bearings are not designed for high speeds.

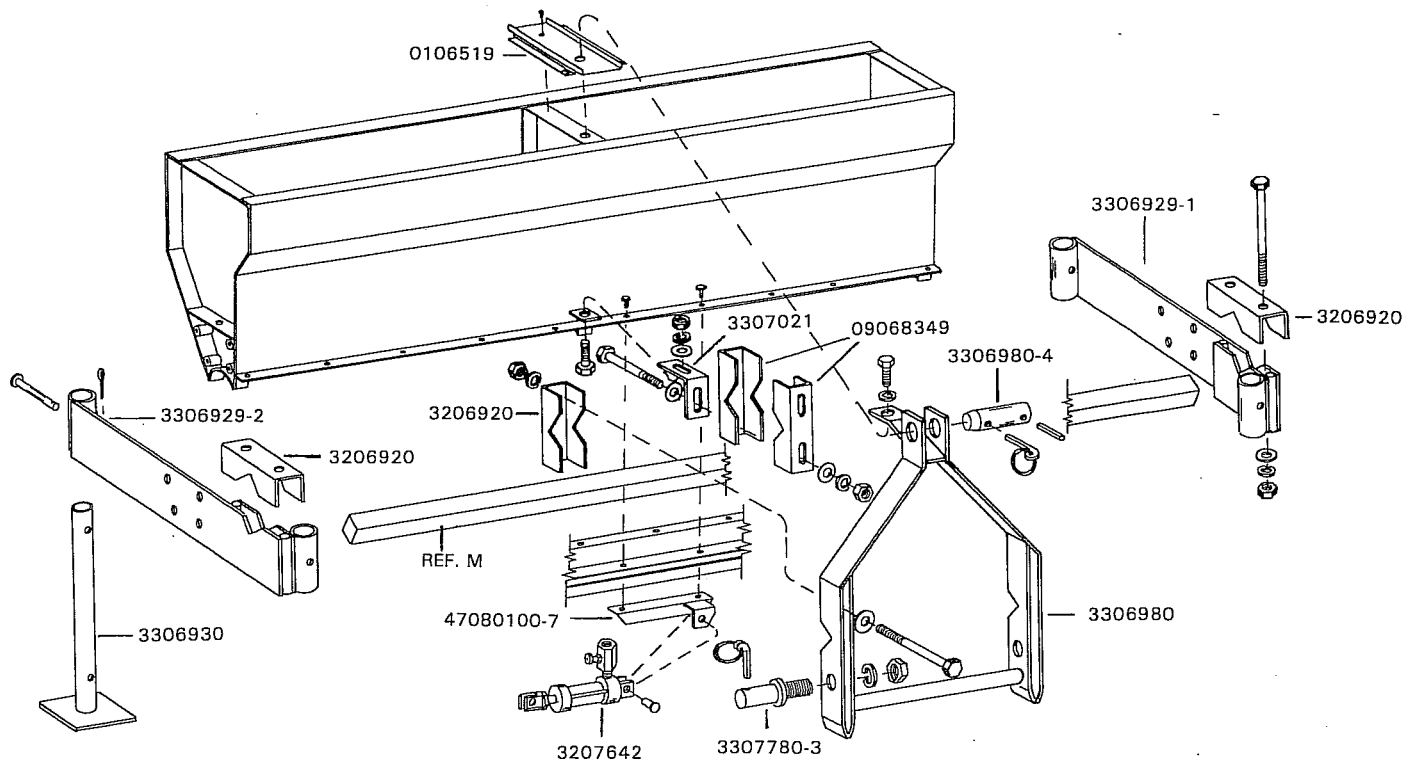

INSTALLATION OF REAR-MOUNTED SPREADER ATTACHMENTS

1. With hopper assembly resting on its back, remove crating. **Note:** Do not remove protective strip covering bottom until installation has been completed. Hubs and wheels should be installed as described on page 6.

2. Remove rain trough (0106519), covers, parking stands (3306930) and hardware from inside hopper.

3. Install the four parking stands in brackets attached to tool bar clamping end plate (3306929-1) in place, and secure, using four clevis pins and four hair pin cotters. Invert hopper to rest on parking stands.

4. Install rotors, rain trough and covers as described on pages 6 and 7.

5. Attach 3-pt. hitch assembly (3306980) to tool bar using two clamp caps, bolts, wrought washers, lock washers and hex nuts provided in 3-pt. hitch assembly bundle.

6. Attach tab in place at top of 3-pt. hitch to rain trough and center frame of hopper top, using bolt and lock washer provided.

7. Install yoke pin (3306980-4) through top of 3-pt. hitch and secure with klick pins provided.

8. Insert two klick pins into hitch pins in place near bottom of 3-pt. hitch.

9. Remove wooden protective strip from bottom of hopper. Machine is ready for operation. **Note:** After a short period of use, check nuts and bolts. Tighten if necessary.

CAUTION: Do not trail machine behind vehicles at high speeds, as spreader's wheel bearings are not designed for such use.

Rear-Mounted 10 Series Spreader Attachment

Ref.	Pcs.	Part No.	Description
	1	47080100-7	Mounting bracket hydraulic cylinder
	1	3207642	Hydraulic cylinder
M	1	3267586-76	Tool bar, 1006 S & T series
	1	3287586-100	Tool bar, 1008 S & T series
	1	32107586-124	Tool bar, 1010 S & T series
	1	32127586-148	Tool bar, 1012 S & T series
	1	3306929-1	End plate, tool bar clamping
	1	3306929-2	End plate, tool bar clamping
	2	09068349	Clamp cap
	2	3206920	Clamp cap
	1	3307021	Bracket, right angle, slotted
	4	3306930	Parking stand
J	2	3306951	Stub drive used in place of 0106751
	1	0106548	Axle, left
	1	0106549	Axle, right
	4	010655-3	Collar, wheel hub
	2	010656-3	Clutch pin
	2	010656-4	Lever, clutch pin
	2	E01-0666-4	Spring clutch
	2	0106360	Wheel hub
	1	3306980	3-pt. hitch assembly
	2	3206920	Clamp cap
	2	3307780-3	Hitch pin
	1	3306980-4	Yoke pin.
	2	R01-0015-020	Disc wheel

For common spreader parts numbers, see page 8.

SPECIFICATIONS

Models and sizes--1006T, 6 ft. (1.8m); 1008T, 8-ft. (2.4m); 1010T, 10-ft. (3m); 1012T, 12-ft. (3.6m). Adding R (rear) to preceding model numbers designates a 3-pt hitch end-wheel driven model.

Hopper capacities--1.5 cu. ft./ft. Or 100 lb. Per foot of hopper (50kg/m), based on contents density of 65 lb. per cu. ft.

Hopper--heavy gauge steel, polyester powder coated.

Bottom & slide--Cold roll steel bottom, polyester powder coated. Stainless steel shutoff closures strips.

Hopper openings--diamond-shaped, 1-1/2-inch long; 10T models, 4 inches apart.

Rate gauge--precision cam gauge.

Rotor--positive acting Shur-Feed rotor; 10T has powder angles for high rates in powdery materials.

Rotor bearings--oil-impregnated double sleeve type with grease well between with grease fittings.

Spread plate--standard on 10T Series.

Lever-shutoff--standard with trailing models.

Hydraulic shutoff--standard on all mounted models, available for trailing models.

Tractor hitch--standard on trailing models, plus stub hitch at rear of hopper to tow non-ground engaging implement.

Ground drive--standard on trailing models and 3-pt. Hitch models. Non-load bearing stub axle runs from wheel into hopper, engages with end of rotor, can be removed without tools. Positive, three-position clutch with neutral, drive, and third position for removing rotor.

Hydraulic drive--Optional for implement-mounted packages.

Electric drive--Optional for implement-mounted packages.

Wheels--6.70 x 15 implement rim, or wide-base 11L15 optional, less tires. Bearings are roller burnished cast iron with grease well.

Lid--separate weather tight lid with spill-guards for each half of hopper, positive locking; easily removable; reversible; safety stops.

Distance between wheel centers--6 to 12-ft. Trailing models "dished in" 14-in. More than nominal hopper width; wheels "dished out", add 5 inches.

Overall widths--6 to 12-ft. Trailing, 27 inches wider than hopper width.

Shipping weights--approximate uncrated weights listed below in pounds (kilograms).

10T Series Spreader Uncrated weights				
lb(kg)				
Size	6	8	10	12
Trailing	440 (200)	506(230)	569(255)	660(300)
3 pt. Hitch	587 (265)	673 (305)	758 (340)	873 (390)
Implement-mtd (Hopper only)	278 (126)	379 (172)	477 (217)	579 (263)



Gandy Company
 528 Gandrud Road
 Owatonna, MN 55060
 Ph: 507/451-5430 800/443-2476 Fax: 507/451-2857